



INSTITUTE OF MARINE RESEARCH
HAVFORSKNINGSINSTITUTTET





FHF-prosjekt 900085 NFR(FHF) Prosjekt: Welfare tools

Nye redskaper for overvåking av oppdrettsmiljø og fiskevelferd

Tore S Kristiansen, Lars H. Stien, Trygve Gytre, Havforskningsinstituttet
Øyvind Aas Hansen, Bjørn Steinar Sæter, Nofima-Marin

Hvorfor overvåke oppdrettsmiljø og fiskeatferd?

- Vi trenger mer kunnskap om sammenhenger mellom oppdrettsmiljø, helse og velferd og produksjonsresultater!
 - Det finnes svært lite (tilgjengelig) dokumentasjon
- For å vite hvordan en skal optimalisere produksjonen må en vite hva som er årsakene til tidligere produksjonsresultater
- Enhver avansert prosessindustri må vite hva som skjer i prosessen – resultatmarginer vil minske over tid!
- Det vil trolig bli behov for å dokumentere over for myndigheter og kunder at regler er fulgt og at fisken er vokst opp under gode betingelser?

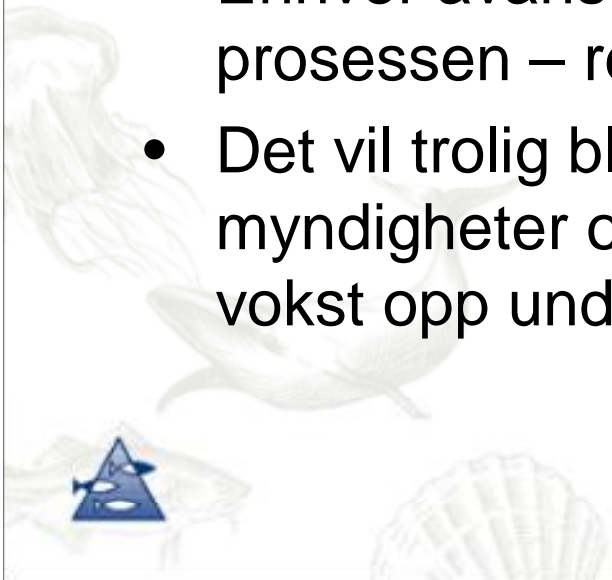

Laksens mål:

1) Overleve 2) Vokse 3) Reproducere



Oppdretterens mål (med laksen):

- God overlevelse
- God vekst/produksjon
- God fôrutnyttelse
- (ikke reproduksjon)
- God kvalitet
- God pris
- God lønnsomhet
- Godt omdømme
 - Lav miljøpåvirkning – bærekraftig produksjon



Laksens utfordring

- Hva skal en bruke ressursene på?
 - Trygghet (predator-/sykdoms-/miljøforsvar)?
 - Matinntak (jakt og fordøyelse)?
 - Muskler eller gonader (tidlig eller sein modning)?



RESSURSENE ER BEGRENSET !

- Gjennom evolusjonen har laksen utviklet evner til å justere allokering av ressurser etter (antatt) kommende behov
- Laksens bevisste og utbevisste fortolkning av miljøet styrer ressursallokeringen
- Dette påvirkes både av arv, miljø og erfaring/læring/trening

–Obs! Mekanismene er ikke tilpasset merdoppdrett!

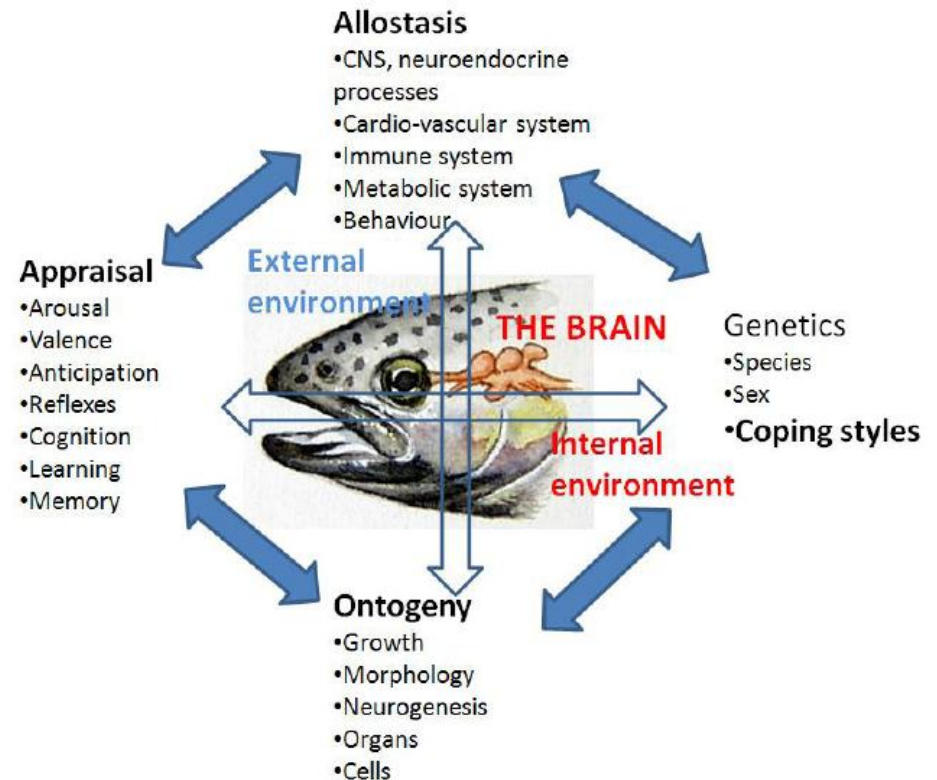

OPPDRETTSMILJØ OG PRODUKSJONSRUTINER PÅVIRKER HVORDAN LAKSEN BRUKER SINE RESSURSER



Enhver miljøendring medfører større eller mindre kostnader til stressmestring og justering av fysiologiske prosesser

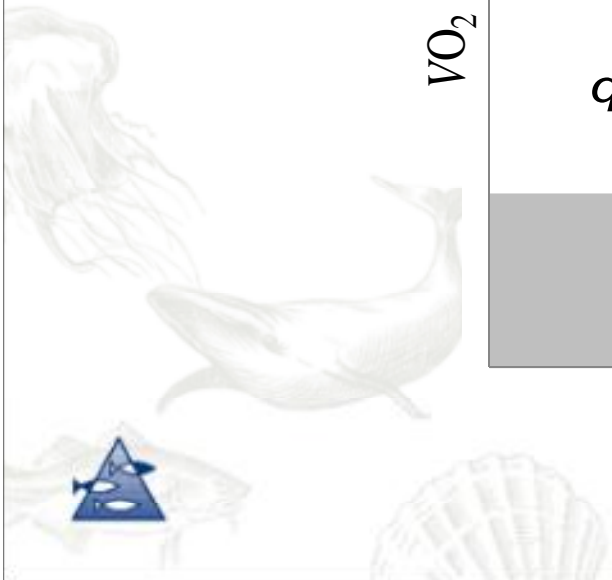
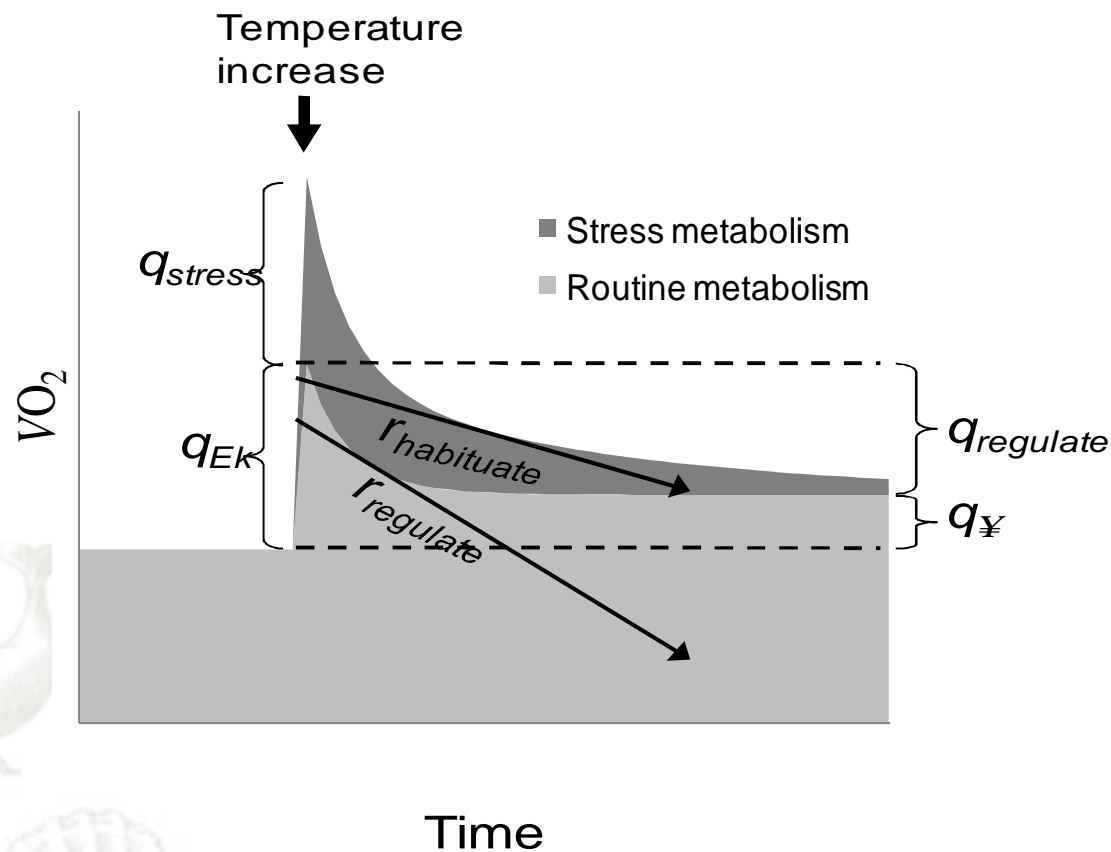

Oppdretterens utfordring

- Hva skal en bruke ressursene på?
 - Trygghet (godt og stabilt miljø (lokalisering), sikker teknologi, stressreduksjon/håndtering, parasitt/sykdomsbehandling,
 - Matinntak (fôrmengde og kvalitet, oksygentilførsel)?
 - Muskler eller gonader? (avl, lysstyring, ..)

Avegning VELFERD vs. PRODUKSJON

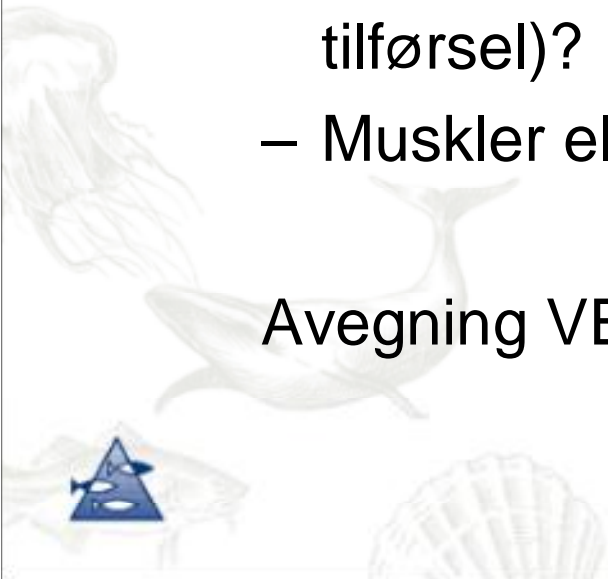

Merdoppdrett – oppdrett på naturens premisser



Merdoppdrett – oppdrett på naturens premisser

Hydrografi	Meteorologi	Økologi	Drift
Temperatur	Sollys	Predatorer	<i>Anleggstype, posisjonering, og drift</i>
Salinitet	Vind	Parasitter	<i>Fisketype og tetthet</i>
Vannstøm	Nedbør	Begroingsorganismer	<i>Fôr og ernæring</i>
Turbiditet	Atmosfærisk trykk	Alger og plankton	<i>Parasitt og sykdoms behandling</i>
Vannkjemi		Maneter	Lyssetting
Tidvann Tidvann Tidvann Tidvann		Bakteriervirus Bakteriervirus Bakteriervirus Bakteriervirus	



Variierende oksygenverdier

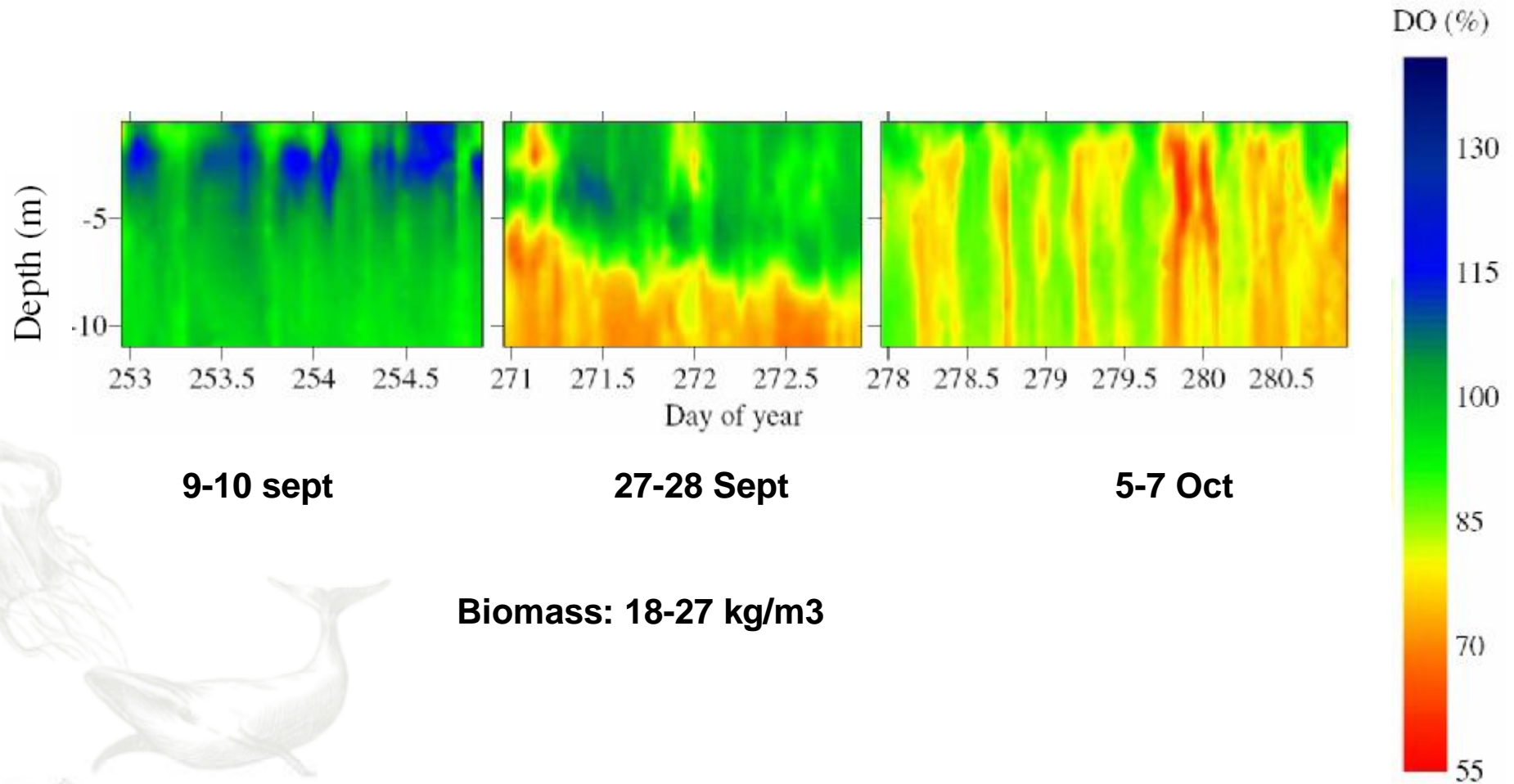

Biomass: 18-27 kg/m³

From Johansson et al. 2006

Juli

Aug

Sep

Okt

Nov

Des

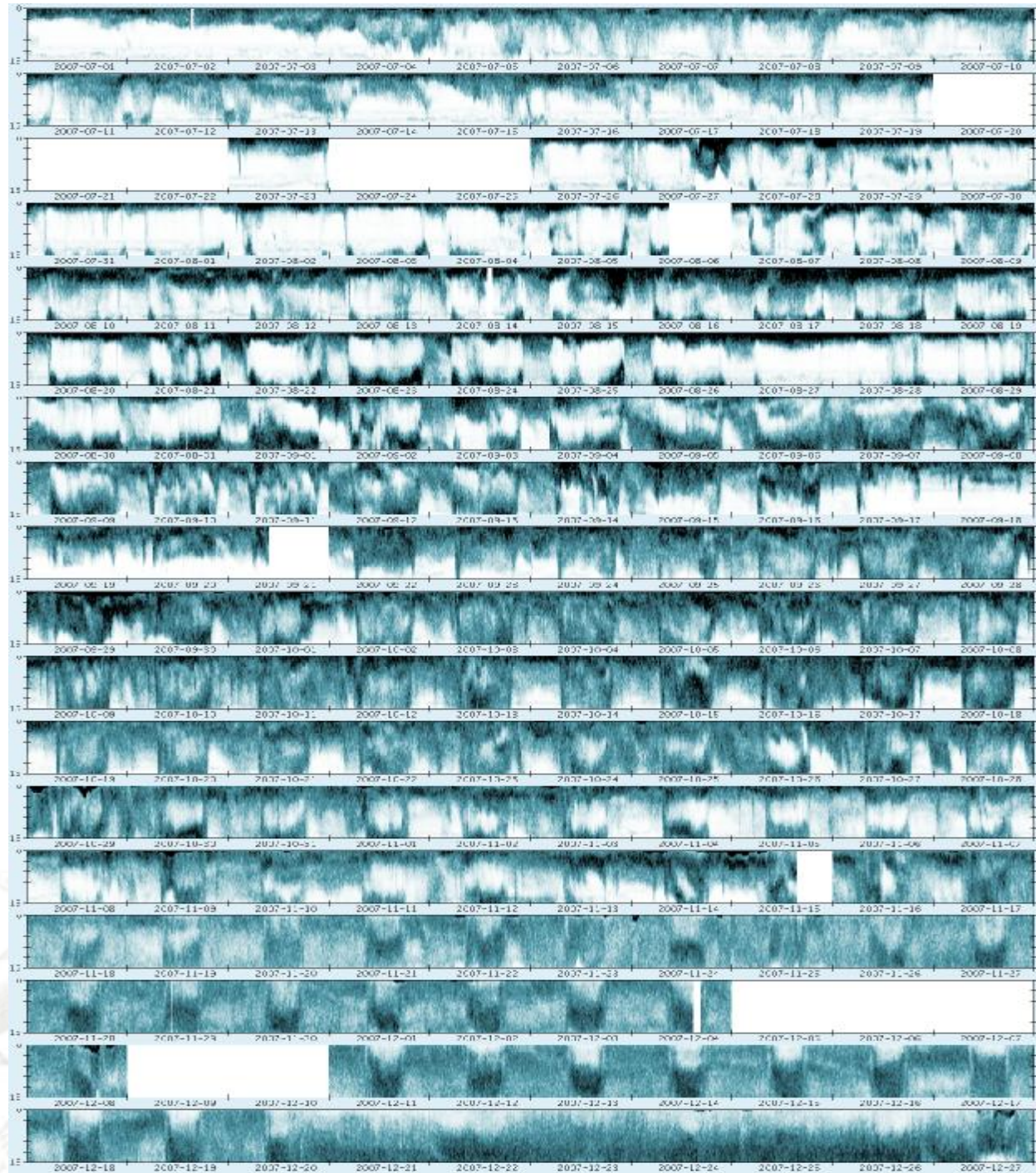

MÅL: Prosjekt WELFARE TOOLS (2008-2009):

- Utvikle og integrerer teknologi for "online" overvåking av merdmiljø (welfaremeter), fiskefysiologi (telemetry) og atferd (ekkolodd), samt økofysiologiske modeller, i et integrert system for helhetlig vurdering og dokumentasjon av stressnivå og fiskeatferd i laksemerder.
- Bruke systemet til å studere effekter av miljøvariasjon på fiskens respirasjons, spise og svømmeatferd og stressnivå, både i kontrollerte laboratorieeksperimenter og i fullskala sjøanlegg i høy og lavrisiko sykdomsområder.
- Utvikle ekspertprogramvare for helhetlig overvåking av fiskevelferd basert på denne overvåkingsteknologien, værdata, produksjonsdata fra oppdrettsanlegg, og tilgjengelig kunnskapsbaserte modeller.

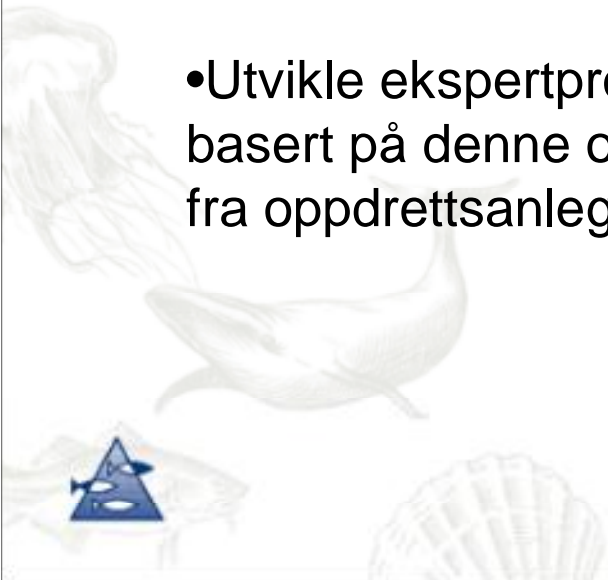

Prosjekt WELFARE TOOLS:

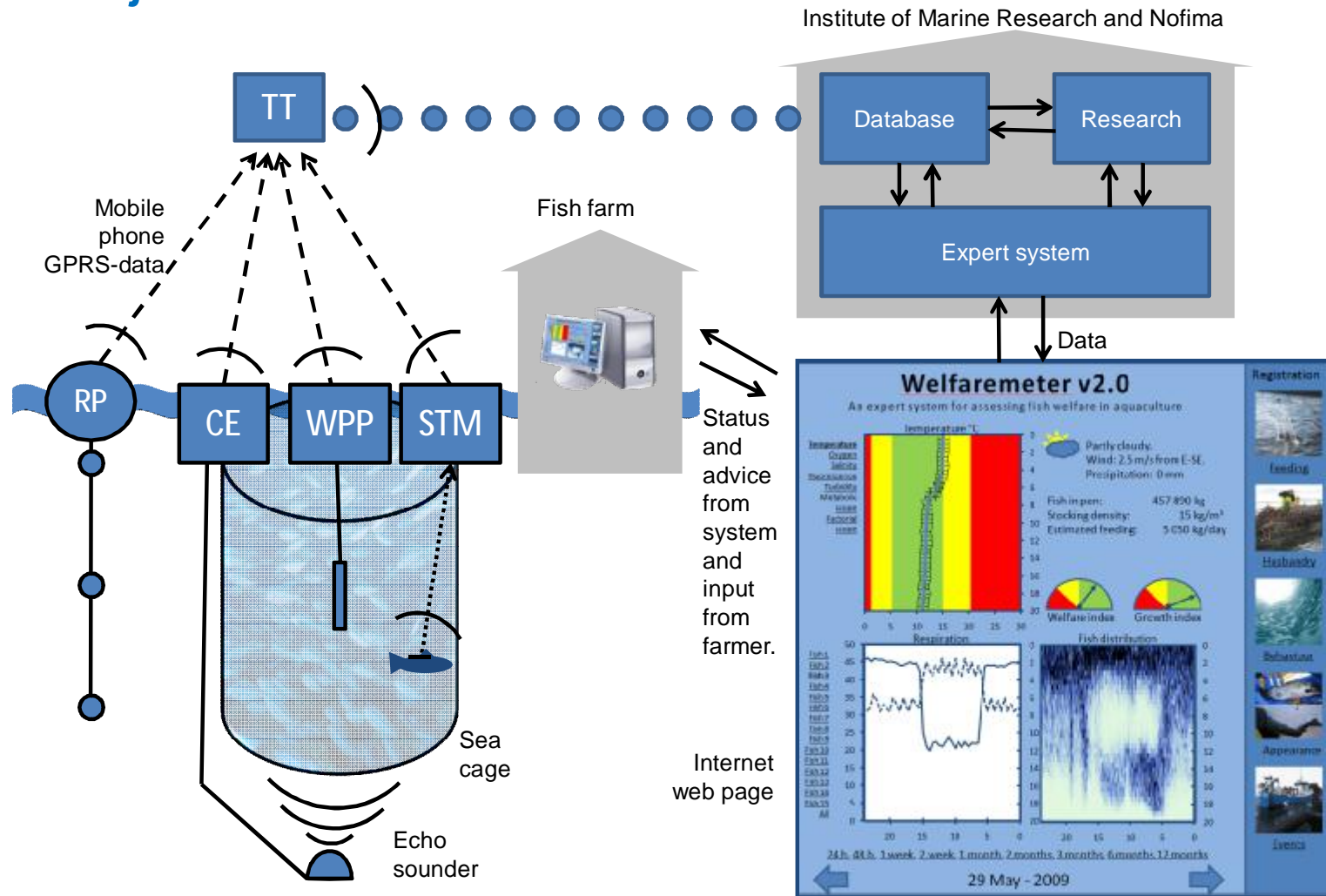

Prosjekt WELFARE TOOLS:

WP1 Integrering av overvåkingsteknologi

1. Velferdsmeterbøye målesystem
2. Velferdsmeter referansesensor
3. Velferdsmeter Internett-brukergrensesnitt
4. SmartTag digital – pustefrekvensmåler
5. Merdøye Online – ekkointegrator
6. Velferdsmeter Modellbasert ekspertsystem



- WP2 - Validering av Smart-tag digital som forskningsverktøy
 1. FHF prosjekt: Utvikle Smart-tag digital
 2. Evaluere og optimalisere plassering og kirurgisk protokoll for laks og evaluere effekter av merking på funksjonalitet av merke og fiskeatferd
 3. Respons på varierende oksygenkonsentrasjoner

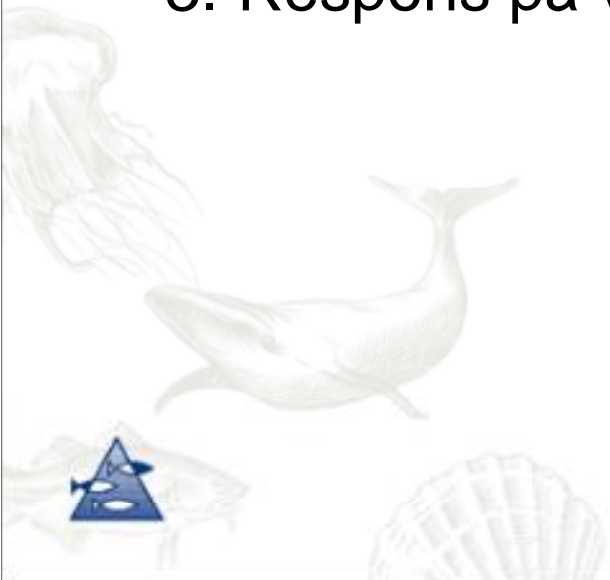

SmartTag digital

Digital (left) and analog (right) SmartTag

- Digital SmartTag finansiert av FHF utviklet av Nofima Marine & Thelma Biotel
- 13 mm diameter, 39 mm langt, vekt = 7 g i vann
- Måler pustefrekvens, prustevolum, og peøet svelging i fritt svømmende fisk
- => Indikator for fiskevelferd og stress – tidlig varsling
- => Linket til metabolsk kapasitet - oksygenforbruk
- => Optimalisering av fôring og produksjonsregimer
- Indre (bukhula) eller ytre (rygg) plassering av merket.
- Merket fisk gjenkjennes og fjernes på slaktelinja (i.e. må gis tydelig ytre kjennetegn)



THELMABIOTEL  Nofima
marin

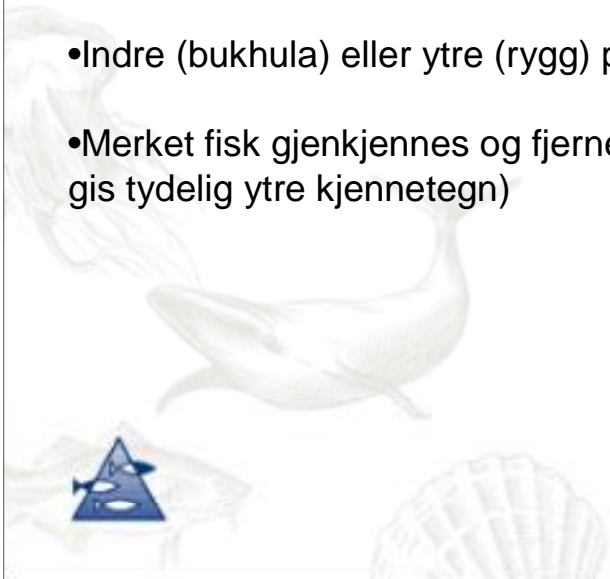



Laks med ytre SmartTag



Instrumentering laks med SmartTag

Alle foto: Frank Gregersen, Nofima Marin



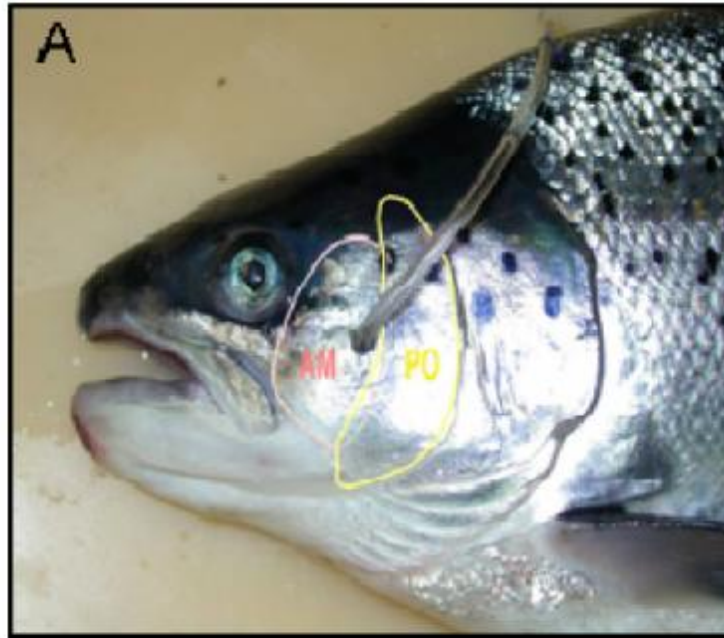

Fig. 18. Ytre (A) og indre (B) føring av trykksensorslange for bruk på laks (AM = adductor mandibulae, PO = preoperculum).Foto: Christian Koren.



Fig. 15. SmartTag-digital (STd) merket er 39 x 13 mm, veier ca 7 gram i vann og har en estimert batterilevetid på 7 - 12 måneder. Foto: Frank Gregersen / NOFIMA og Thelma Biotel AS.



SmartTag (Nofima Marine)

Example digital SmartTag (dST) measurements

Digital SmartTag - Respiratory volume
(Free-swimming Salmon, *Salmo salar*, ID 141)

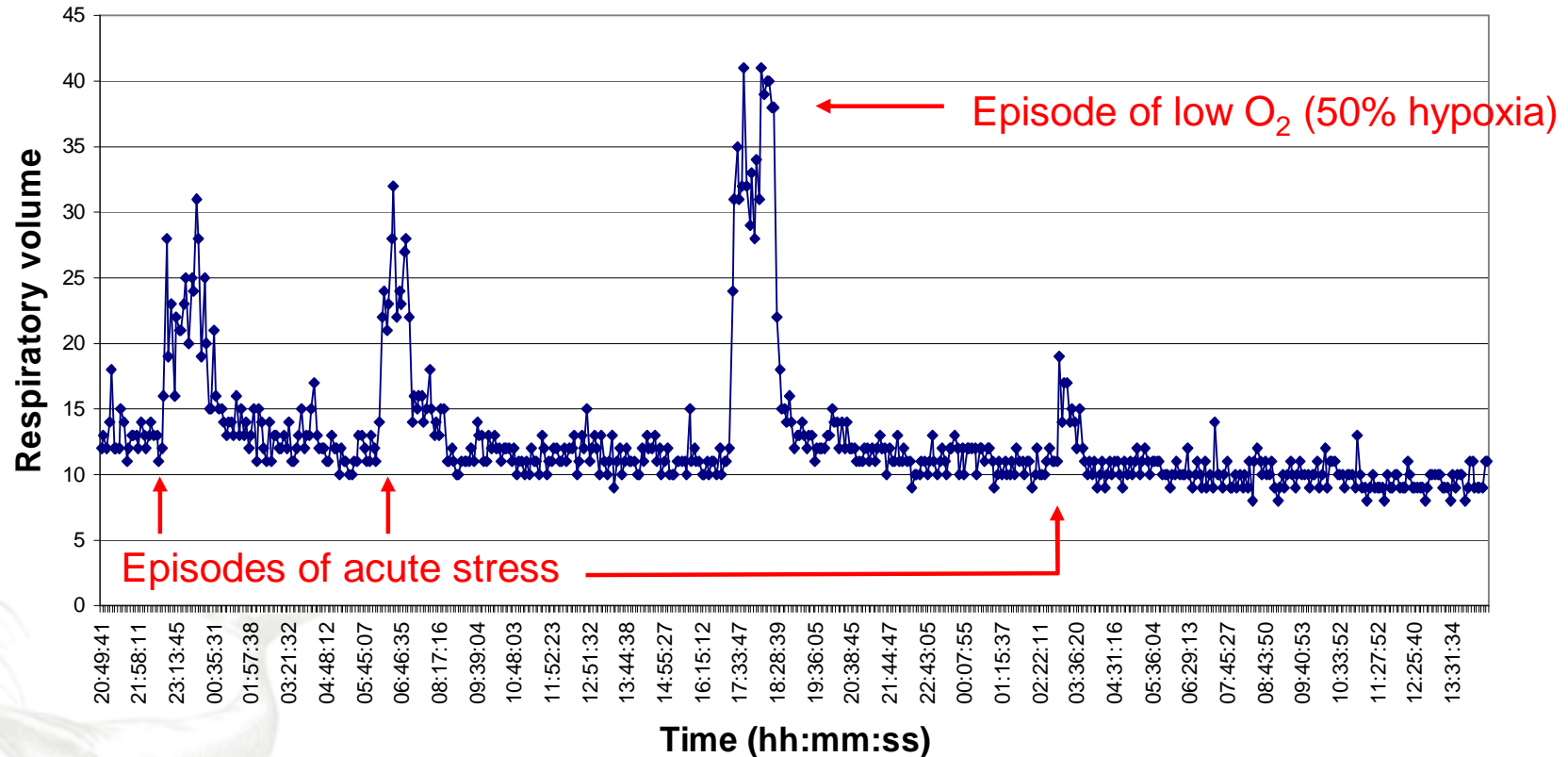

I.e. Respiratory volume doubled with episodes of acute stress, tripled by episode of low water oxygen

- **WP3 – Integrert system og to feltstudier**
 1. Sette opp et fullt integrert system på to oppdrettslokaliteter
 2. Teste og evaluere overvåkingsredskapene i min 6 mnd
 3. Måle ventilasjonsrater hos laks i store merder under varierende oksygenforhold
 4. Identifisere miljøforhold som utløser klare fysiologiske responser hos enkeltfisk
 5. Sammenligne atferd til merket STd fisk med fordeling av fisk målt med ekkolodd
 6. Bygge opp langtids-datasett og optimalisere database og ekspertsystem for helhetlig velferdsovervåking.





WELFAREMETER

2gen

Et av hovedformålene ved WELFARE-TOOLS prosjektet er å utvikle produkt for overvåking og analyse av forholdene i en oppdrettsmerd. Et av disse produktene er en automatisk profilerende målebøye.

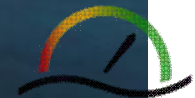



WELFAREMETER

2gen

Denne bøyen blir utviklet i samarbeid med SAIV AS, STM Maskinering AS og Argus Remote Systems AS.



Fra venstre: Per Gunnar Saksvik (STM AS), Gunnar Sagstad (SAIV AS) og Frode Korneliussen(Argus)

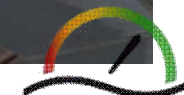



WELFAREMETER

2gen

Dette er en bøye spesialutviklet for å måle vannkvalitet fra topp til bunn i en oppdrettsmerd.

Bøyen profilerer merden ved å senke og heve en målesonde opp og ned i merden.

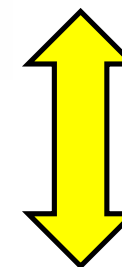

Temperatur
Saltholdighet
Dybde
Oksygen
Turbiditet
Fluorescens





WELFAREMETER

2gen

Når bøyen har foretatt en profil sendes dataene til en sentral database hvor de blir analysert av ekspertprogramvare.

Bøyen profilerer vannmiljøet ved å senke og heve en målesonde fra topp til bunn i merden.

Måledataene og resultatene fra ekspertprogrammet legges direkte ut på en internettside.

(Brukenavn og passord)

Web page
Easy communication
between fish farmer
and system

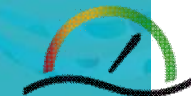
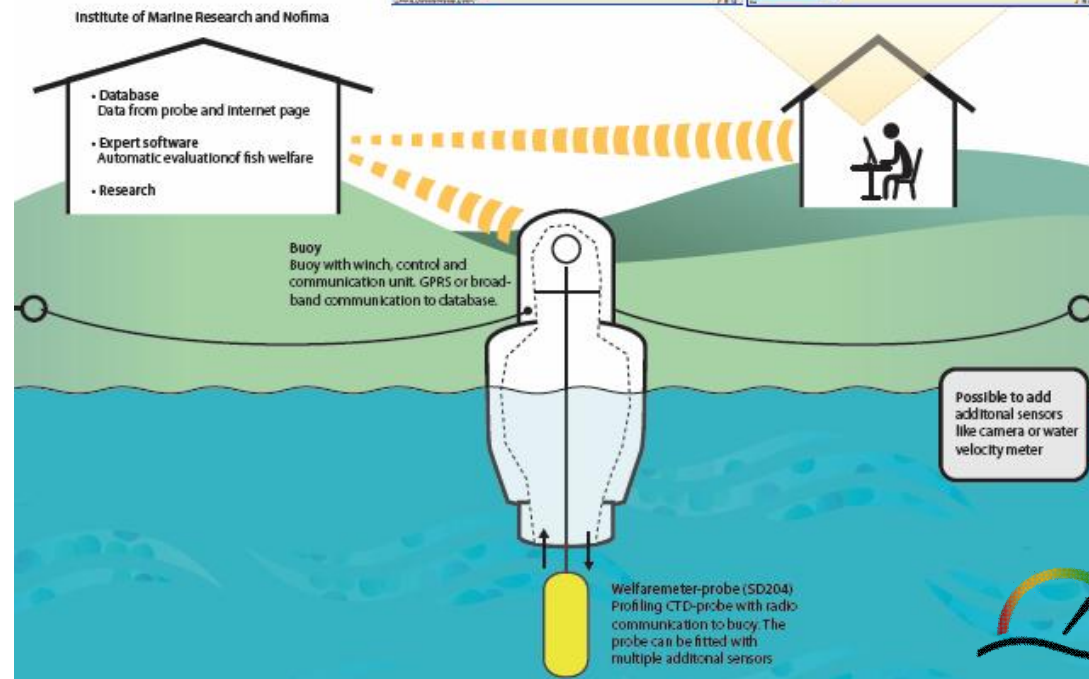
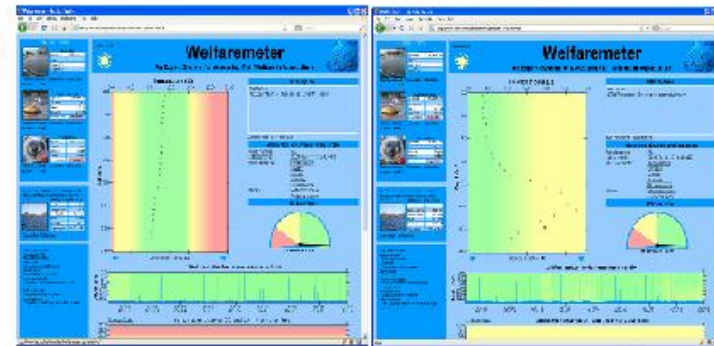



WELFAREMETER

2gen

Ekspertprogramvaren gir en evaluering av miljøforholdene som enten gode, mindre gode eller potensielt skadelige for fisken. Dagens versjon av ekspertprogramvaren tar hensyn til hvordan temperatur, oksygen, saltholdighet, turbiditet (partikkeltetthet) og fluorescens (planteplanktontetthet) påvirker oppdrettslaks.

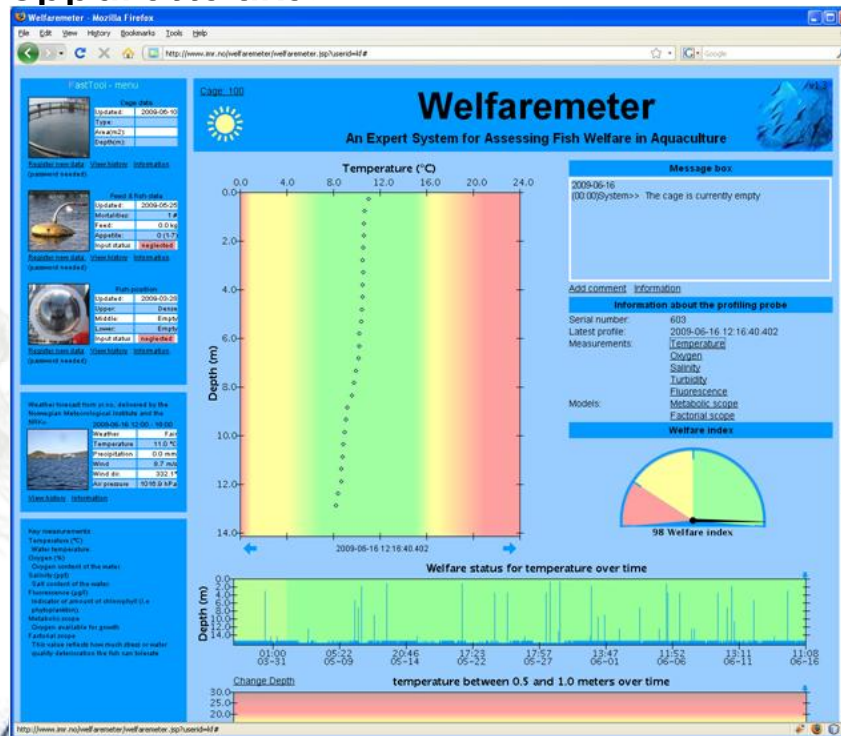

Temperatur

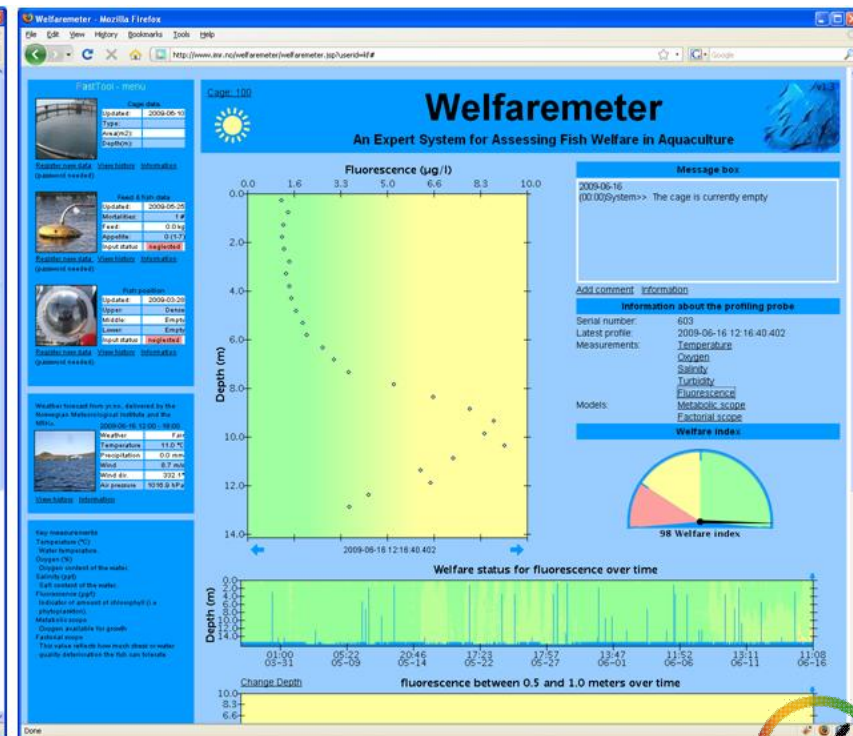

Fluorescens

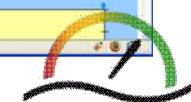



WELFAREMETER

2gen

I tillegg til en konkret vurdering av miljøet, modellerer ekspertprogrammet fiskens potensial til vekst (metabolsk scope) og robusthet overfor stress (relativ metabolsk scope) under de rådende miljøforhold.

Disse to målene, som er basert på laksens beregnede evne til å omsette oksygenenergi til svømming, stoffskifte, immunforsvar, fordøyelse og vekst, skal hjelpe oppdretteren å avgjøre hvor mye fisken bør føres og hvor vidt det kan iverksettes operasjoner på anlegget som kan virke stressende på fisken (f.eks. trenging i forbindelse med avlusing).

Ekspertprogrammet beregner også en velferdsindeks fra 0 (katastrofalt) til 100 (perfekt).



WELFARE METER

2gen

Mye av forsinkelsen skyldes at vi har fått et stadig høyere ambisjonsnivå

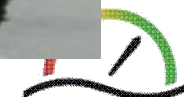
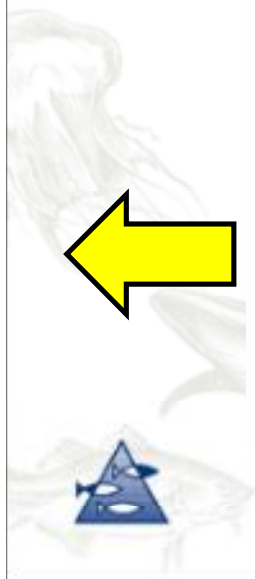
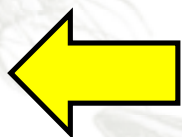
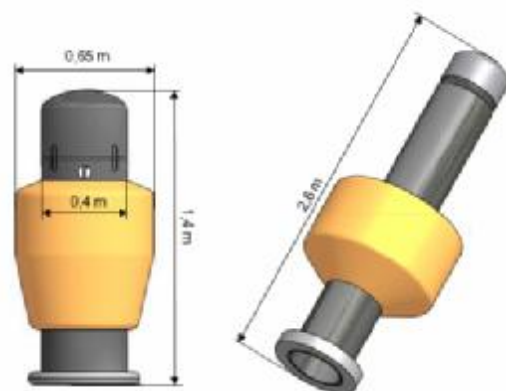
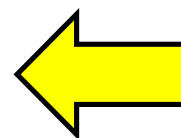
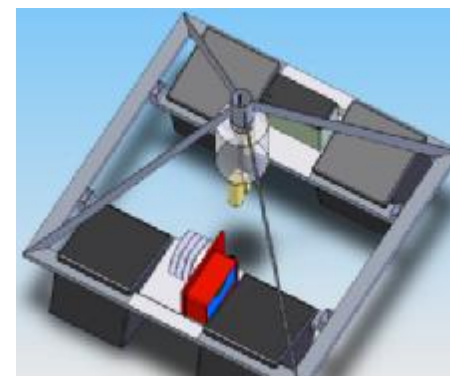
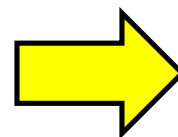
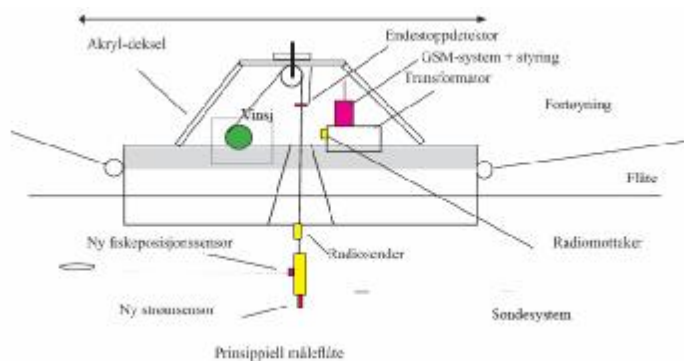



WELFARE METER

2gen

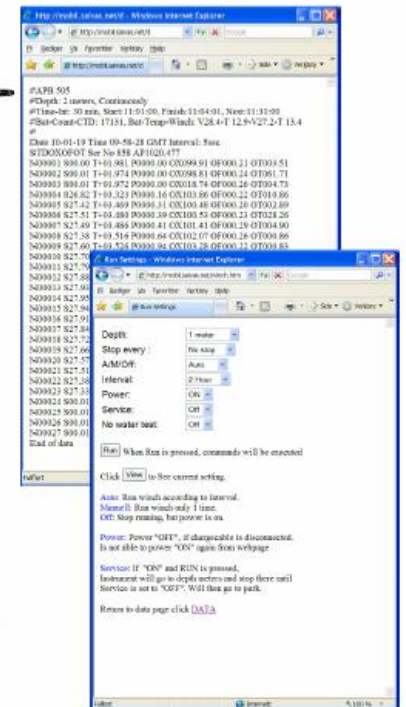
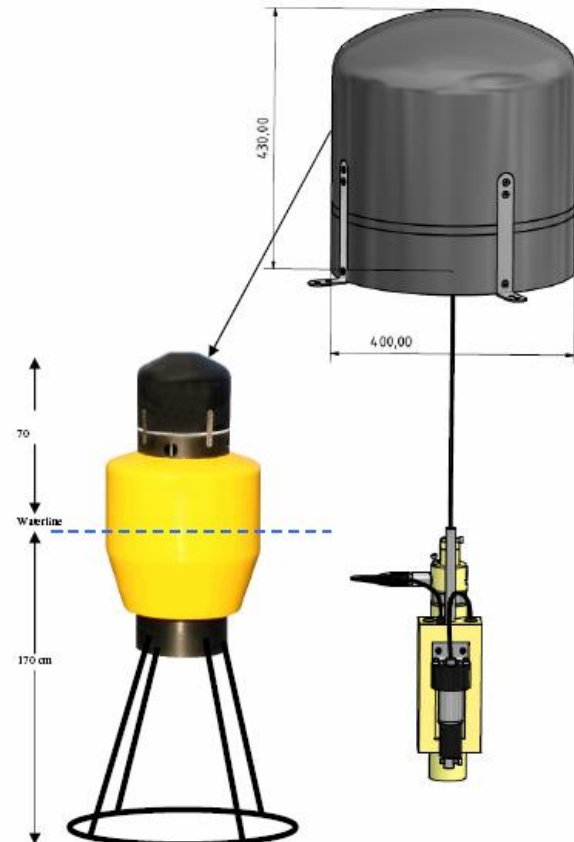
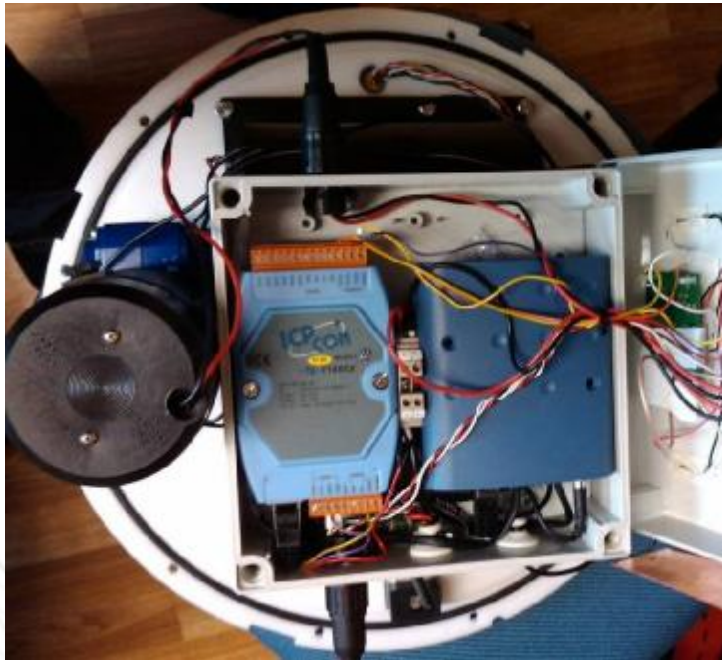



WELFAREMETER

2gen

Men vi har en del resultater fra det opprinnelig prototypsystemet av Velferdsmeteret.

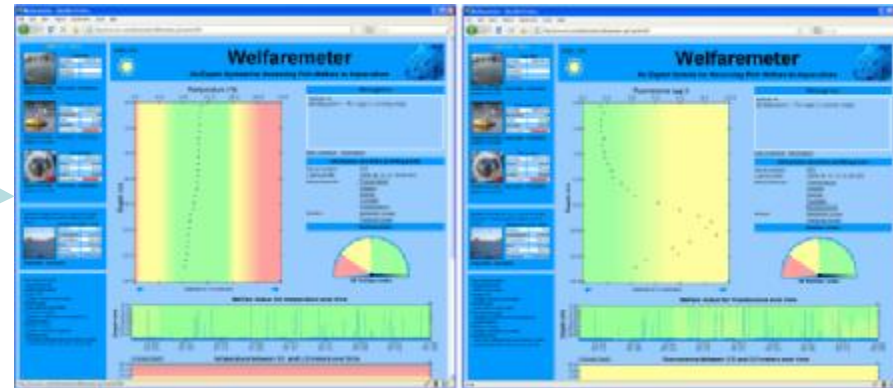
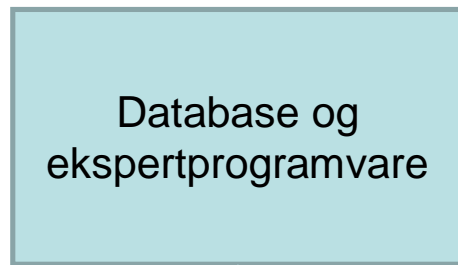

GPRS

Vinsj

Radio

Landenhet med vinsj, kontrollenhet og modem



Ct





WELFAREMETER

1gen

Men vi har en del resultater fra den opprinnelige prototypen



I bakgrunnen: Trygve Gytre. Trygve Gytre er hovedmannen bak Velferdsmeterkonseptet.





WELFAREMETER

1gen

Welfaremeter - Mozilla Firefox

File Edit View History Bookmarks Tools Help

http://www.lix.no/welfaremeter/welfaremeter.jsp?userid=4#

FastTool - menu

	Cage data
Updated:	2009-06-10
Type:	
Assembly:	
Depth(m):	

[Dashboard data](#) [View history](#) [Information](#)
(password needed)

	Feed data
Updated:	2009-05-22
Meatfactor:	1.4
Feed:	0.0 kg
Appetite:	0.017
Appt status:	neglected

[Dashboard data](#) [View history](#) [Information](#)
(password needed)

	Water quality
Updated:	2009-03-26
Upper:	Percent
Middle:	Count
Lower:	Empty
Appt status:	neglected

[Dashboard data](#) [View history](#) [Information](#)
(password needed)

Weather forecast from y.no, delivered by the Norwegian Meteorological Institute, and the NPIU

2009-06-16 07:00 - 16:00

Weather:	Fair
Temperature:	11.0 °C
Precipitation:	0.0 mm
Wind:	0.7 m/s
Wind dir.:	332.1°
Air pressure:	1015.9 hPa

[View history](#) [Information](#)

Key measurements:

- Temperature (°C)
- Water temperature
- Oxygen (%)
- Degree conduct of the water
- Salinity (ppt)
- Subst content of the water
- Fluorescence (ppb)
- Indicates if amount of chlorophyll(a) or phytoplankton
- Metabolic scope
- Oxygen available for growth
- Factorial scope
- Thrombolytic activity (see mark sheet results)
- Quality deterioration the fish can tolerate

Welfaremeter

An Expert System for Assessing Fish Welfare in Aquaculture

Temperature (°C)

Depth (m)

2009-06-16 12:16:40.402

Message box

2009-06-16 00:00 System-> The cage is currently empty

[Add comment](#) [Information](#)

Information about the profiling probe

Serial number: 603
Latest profile: 2009-06-16 12:16:40.402
Measurements: [Temperature](#)
[Oxygen](#)
[Salinity](#)
[Turbidity](#)
[Fluorescence](#)
[Metabolic scope](#)
[Factorial scope](#)

Models:

Welfare index

98 Welfare index

Welfare status for temperature over time

Depth (m)

01:00 03:31 05:22 05-09 20:46 05-14 17:23 05-22 17:57 05-27 13:47 06-01 11:52 06-06 13:11 06-11 11:08 06-16

temperature between 0.5 and 1.0 meters over time

Change Depth

30.0 25.0 20.0

http://www.lix.no/welfaremeter/welfaremeter.jsp?userid=4#





WELFAREMETER

1gen

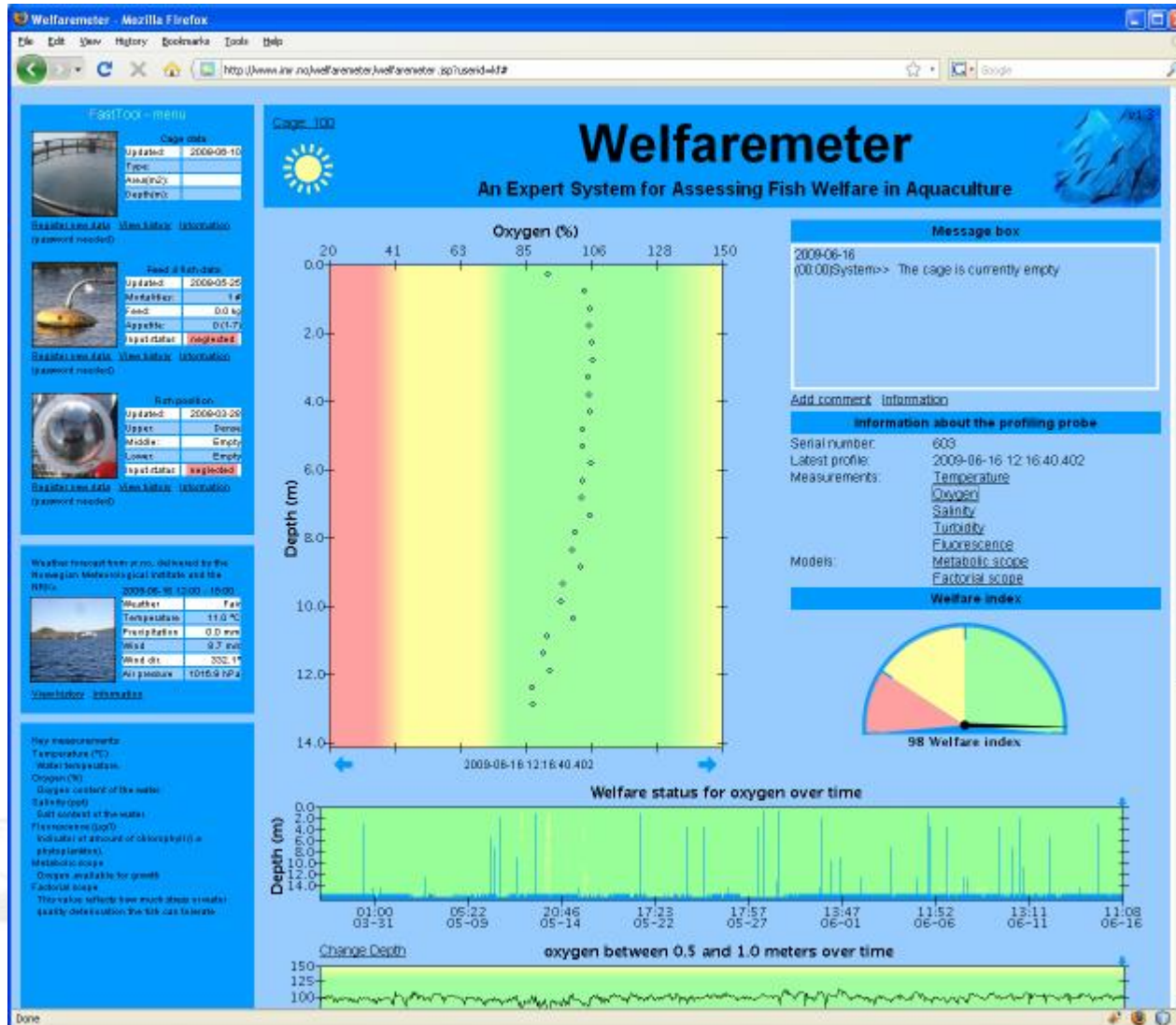



WELFAREMETER

1gen

Welfaremeter - Mozilla Firefox

http://www.aq.no/welfaremeter/welfaremeter.jsp?userid=117

FastTool - menu

Cage data

Updated:	2009-05-10
Type:	
Amount:	
Depth:	

[View](#) [Information](#)

Feed & bath data

Updated:	2009-05-25
Amount:	1 g
Feed:	0.0 kg
Appetite:	0.0 L/h
Hygiene:	Not tested

[View](#) [Information](#)

Water quality

Updated:	2009-03-26
Depth:	0 meters
Mode:	0 meters
Level:	0 meters
Hygiene:	Not tested

[View](#) [Information](#)

Weather forecast from aq.no, delivered by the Norwegian Meteorological Institute and the NRK

2009-06-16 12:00 - 16:00

Weather:	Fair
Temperature:	11.0 °C
Precipitation:	0.0 mm
Wind:	9.7 km/h
Wind dir.:	300.1°
Air pressure:	1015.9 hPa

[View](#) [Information](#)

Key measurements:

- Temperature (°C)
- Water body oxygen
- Oxygen (%)
- Dissolved content of the water
- Salinity (ppt)
- Salt content of the water
- Fluorescence (log)
- Volume of amount of fish (kg) (in a polytunnel)
- Metabolic scope
- Oxygen available for growth
- Carbon dioxide

This value reflects how much stress animals actually detect when the fish can tolerate

Page: 100

Welfaremeter

An Expert System for Assessing Fish Welfare in Aquaculture

Salinity (ppt)

Depth (m)

2009-06-16 12:16:40.402

Message box

2009-06-16 00:00(System)-> The cage is currently empty

[Add comment](#) [Information](#)

Information about the profiling probe

Serial number: 603
 Latest profile: 2009-06-16 12:16:40.402
 Measurements: [Temperature](#)
[Oxygen](#)
[Salinity](#)
[Turbidity](#)
[Fluorescence](#)
[Metabolic scope](#)
[Factorial scope](#)

Welfare index

98 Welfare index

Welfare status for salinity over time

Change Depth

salinity between 0.5 and 1.0 meters over time

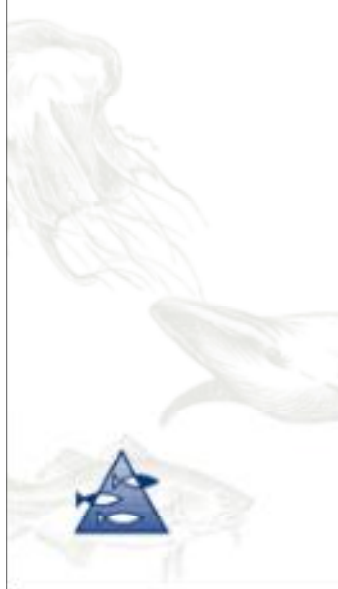



WELFARE METER

1gen

Welfaremeter Mozilla Firefox

File Edit View History Bookmarks Tools Help

http://www.aar.no/welfaremeter/welfaremeter.jsp?userid=412

FastTrack - menu

Cage data

Updated:	2009-05-10
Type:	AMANDA
Depth:	

[See data](#) [View table](#) [Information](#)

Feed & bath data

Updated:	2009-05-25
Metabolic:	1.8
Feed:	0.0 kg
Appetite:	0 (1.7)
Repeat status:	neglected

[See data](#) [View table](#) [Information](#)

Reproduction

Updated:	2009-03-25
Upper:	Empty
Middle:	Empty
Lower:	Empty
Repeat status:	neglected

[See data](#) [View table](#) [Information](#)

Weather forecast from aar.no, delivered by the Norwegian Meteorological Institute and the MHI

Date:	2009-06-16 12:00 - 18:00
Weather:	Fair
Temperature:	11.0 °C
Wind speed:	0.0 m/s
Wind dir.:	9.7 m/s
Wind dir.:	332.1°
Air pressure:	1016.9 hPa

[View table](#) [Information](#)

Key measurements:

- Temperature (°C)
- Water temperature
- Oxygen (%)
- Degree content of the water
- Salinity (ppt)
- Salt content of the water
- Fluorescence (µg/l)
- Indicator of amount of chlorophyll a (phytoplankton)
- Metabolic scope
- Oxygen available for growth
- Factorial scope

The value reflects how much stress animals likely feel within the fish cage today.

Cage: 100

Welfaremeter

An Expert System for Assessing Fish Welfare in Aquaculture

Fluorescence (µg/l)

Message box

2009-06-16 00:00[System]>> The cage is currently empty

[Add comment](#) [Information](#)

Information about the profiling probe

Serial number: 603
 Latest profile: 2009-06-16 12:16:40.402
 Measurements: [Temperature](#), [Oxygen](#), [Salinity](#), [Turbidity](#), [Fluorescence](#), [Metabolic scope](#), [Factorial scope](#)

Models:

Welfare index

98 Welfare index

Welfare status for fluorescence over time

fluorescence between 0.5 and 1.0 meters over time

Key measurements:

- Temperature (°C)
- Water temperature
- Oxygen (%)
- Degree content of the water
- Salinity (ppt)
- Salt content of the water
- Fluorescence (µg/l)
- Indicator of amount of chlorophyll a (phytoplankton)
- Metabolic scope
- Oxygen available for growth
- Factorial scope

The value reflects how much stress animals likely feel within the fish cage today.





WELFARE METER

1gen

Welfaremeter Mozilla Firefox

File Edit View History Bookmarks Tools Help

http://www.aar.no/welfaremeter/welfaremeter.jsp?userid=412

FastTrack - menu

Cage data

Updated:	2009-05-10
Type:	AMANDA
Depth:	

[View data](#) [Information](#)

Feed & fish data

Updated:	2009-05-25
Mortality:	1%
Feed:	0.0 kg
Appetite:	0 (1.7)
Report status:	neglected

[View data](#) [Information](#)

Net operation

Updated:	2009-03-25
Upper:	Down
Middle:	Empty
Lower:	Empty
Report status:	neglected

[View data](#) [Information](#)

Welfaremeter

An Expert System for Assessing Fish Welfare in Aquaculture

Message box

2009-06-16 00:00[System]>> The cage is currently empty

[Add comment](#) [Information](#)

Information about the profiling probe

Serial number: 603
 Latest profile: 2009-06-16 12:16:40.402
 Measurements: [Temperature](#)
[Oxygen](#)
[Salinity](#)
[Turbidity](#)
[Fluorescence](#)
[Metabolic scope](#)
[Factorial scope](#)

Models:

Feed and fish history - Mozilla Firefox

Feed and fish

Close window

Weather forecast from aar.no, delivered by the Norwegian Meteorological Institute and the MHI:

2009-06-16 17:00 - 18:00	
Weather:	Fair
Temperature:	11.0 °C
Wind speed:	0.0 m/s
Wind dir.:	9.7 m/s
Wind dir.:	332.1°
Air pressure:	1016.9 hPa

[View forecast](#) [Information](#)

Key measurements:

- Temperature (°C)
- Water temperature
- Oxygen (%)
- Degree content of the water
- Salinity (ppt)
- Salt content of the water
- Fluorescence (µg/l)
- Indicator of amount of chlorophyll a (phytoplankton)
- Metabolic scope
- Oxygen available for growth
- Factorial scope

This value reflects how much stress remains. A high value indicates the fish can tolerate

Welfare status for fluorescence over time

Welfare index

98 Welfare index

Welfare status for fluorescence over time

Change Depth

fluorescence between 0.5 and 1.0 meters over time





WELFAREMETER

1gen

FastTrack - menu

Cage data	
Updated:	2009-05-10
Type:	AMALINDY
Depth:	

Feed & fish data	
Updated:	2009-05-25
Metabolic:	1.4
Feed:	0.0 kg
Appetite:	0 (1.7)
Repeat status:	neglected

Net-penetration	
Updated:	2009-03-25
Upper:	Empty
Middle:	Empty
Lower:	Empty
Repeat status:	neglected

Weather forecast from ar.no, delivered by the Norwegian Meteorological Institute and the NRK:

2009-06-16 12:00 - 16:00	
Weather:	Fair
Temperature:	11.0 °C
Precipitation:	0.0 mm
Wind:	9.7 m/s
Wind dir.:	202.1°
Air pressure:	1016.9 hPa

Key measurements:
 Temperature (°C)
 Water temperature
 Oxygen (%)
 Oxygen content of the water
 Salinity (ppt)
 Salt content of the water
 Fluorescence (µg/l)
 Indicates if amount of chlorophyll a (phytoplankton)
 Metabolic scope
 Oxygen available for growth
 Factorial scope
 This value reflects how much stress remains
 daily data evaluation the fish can tolerate

Welfaremeter
 An Expert System for Assessing Fish Welfare in Aquaculture

Message box

2009-06-16 00:00[System]>> The cage is currently empty

Information about the profiling probe

Serial number: 603
 Latest profile: 2009-06-16 12:16:40.402
 Measurements: Temperature, Oxygen, Salinity, Turbidity, Fluorescence, Metabolic scope, Factorial scope

Welfare index

98 Welfare index

fluorescence over time

Change Depth
 fluorescence between 0.5 and 1.0 meters over time



Temperature (°C) between 3.0 and 3.5 meters over time

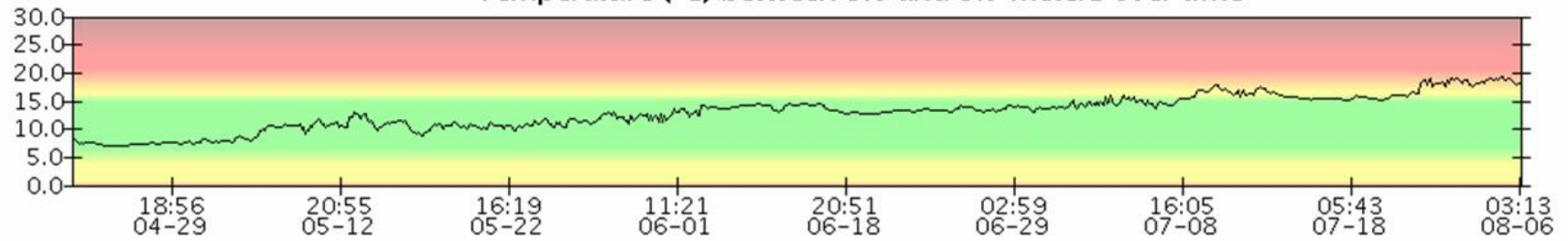

Oxygen (%) between 3.0 and 3.5 meters over time

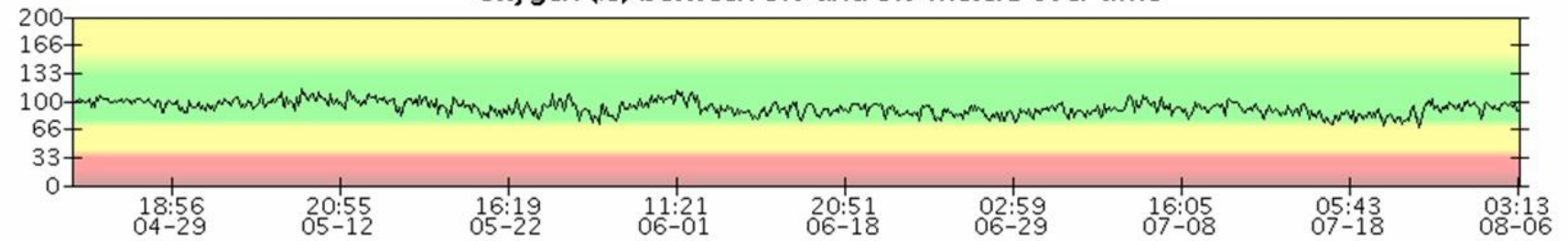

Salinity (ppt) between 3.0 and 3.5 meters over time

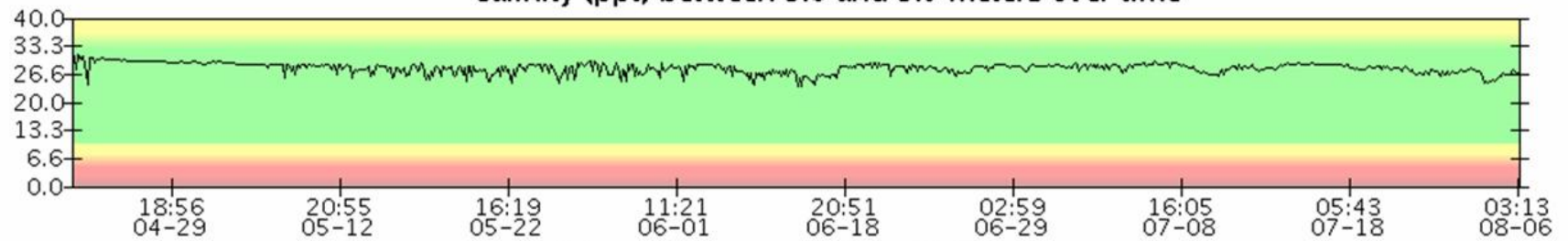

Factorial scope between 3.0 and 3.5 meters over time

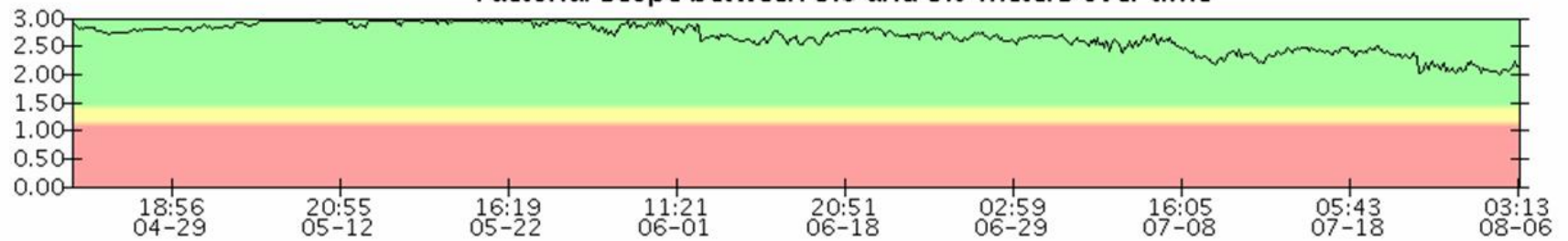



WELFAREMETER

1gen

Eksempler oksygen variasjoner målt med Velferdsmeteret

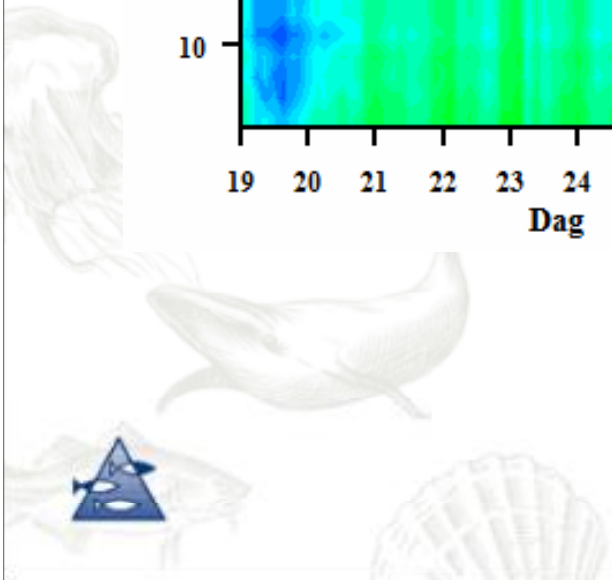
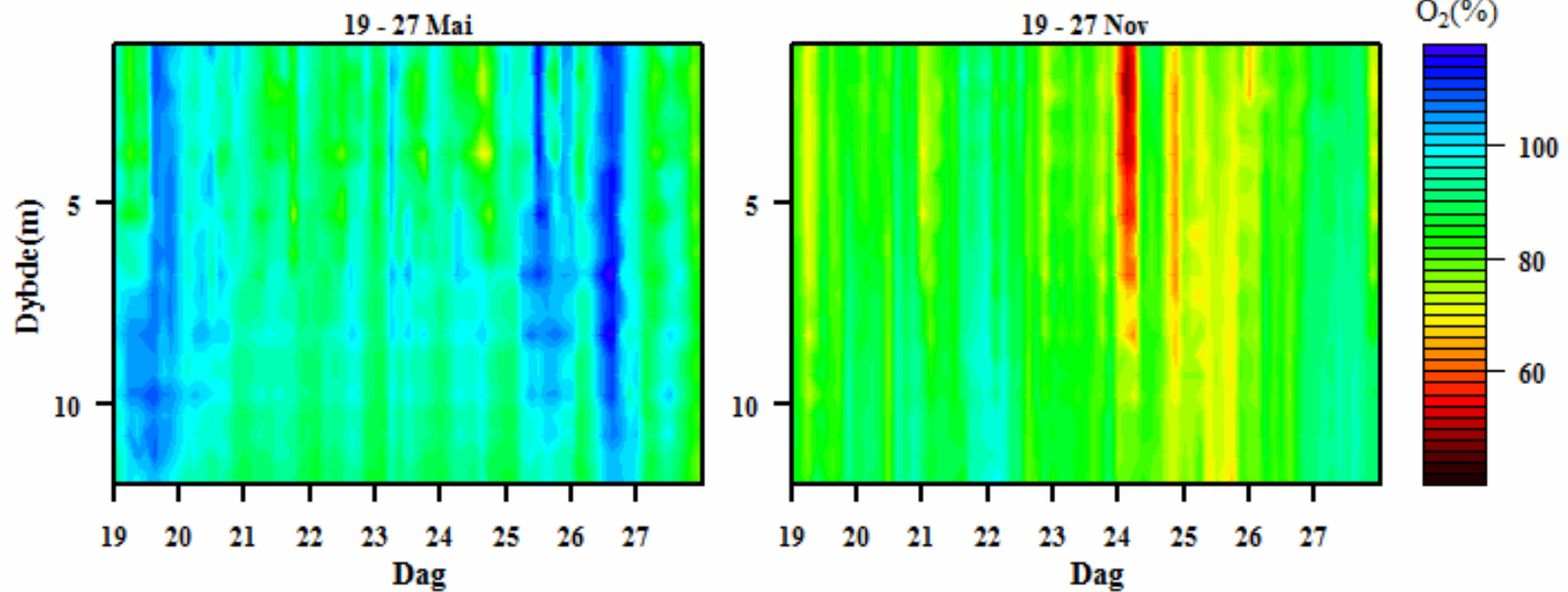



WELFAREMETER ^{1gen}

Ved uttesting av prototypsystemet detekterte modelleringen av fiskefysiologi at laksen flere ganger var utsatt for plutselige temperaturendringer som den på kort sikt ikke klarte å tilpasse seg fysiologisk. Som direkte følge av dette måtte laksen øke oksygenforbruket sitt, noe som igjen ga økt fare for stress og redusert velferd.

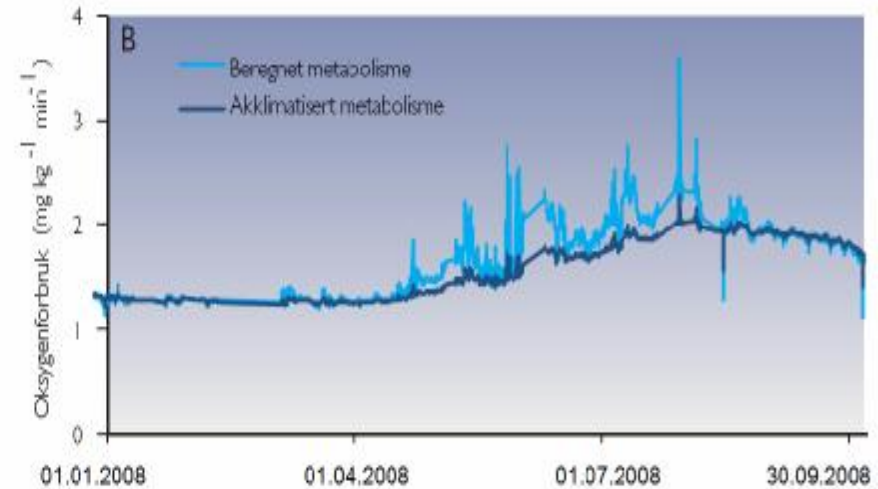
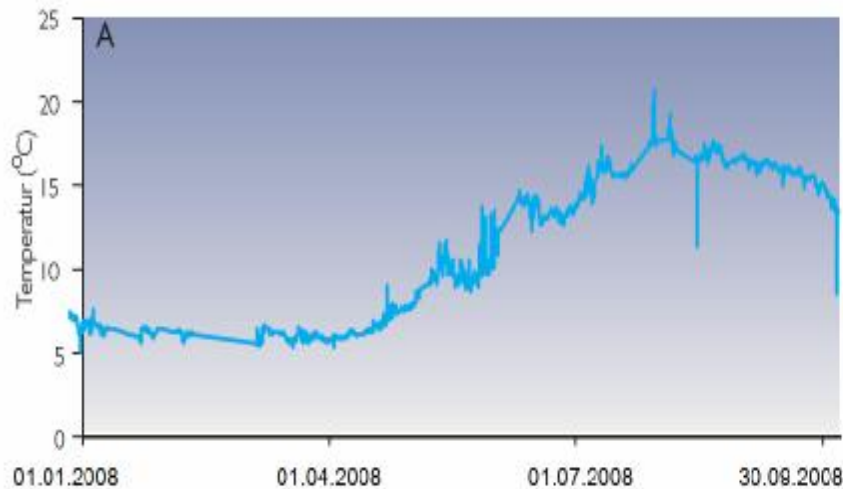



WELFAREMETER

2gen

Ekkolodd er en viktig komponent i det nye Velferdsmeter-systemet.

Både for å finne hvor fisken står i forhold til variasjoner i miljøforholdene, og for å detektere forventningsadferd og unormal adferd (ikke forventet adferd ut fra forholdene),

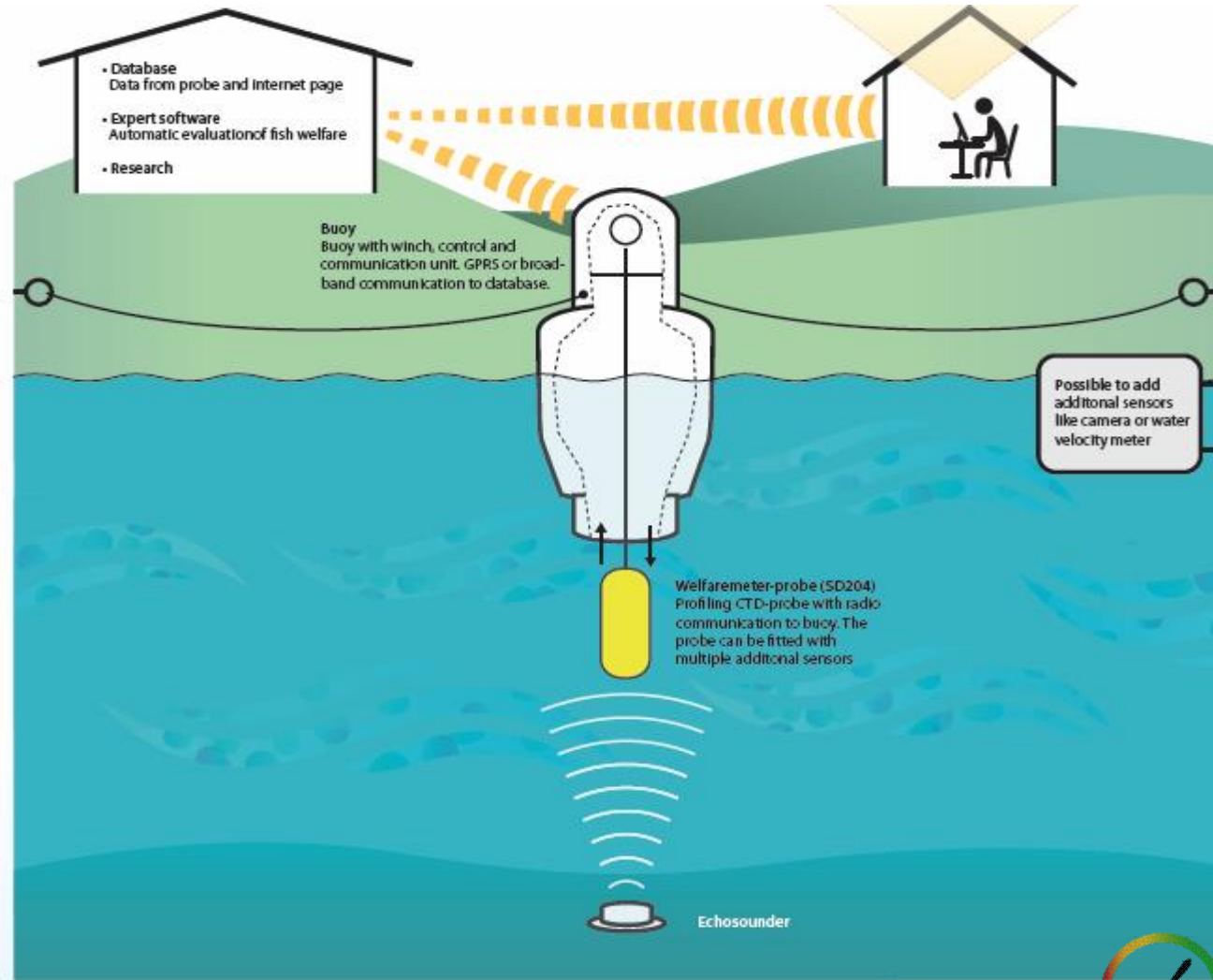

Torfinn Lindem ved Fysisk Institutt (UiO) er hovedansvarlig for å integrere ekkolodd i Velferdsmeter-systemet.

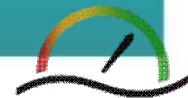



WELFARE METER

Eksempler på adferdsobservasjoner med ekkolodd vs. Miljøforhold i en laksemerd

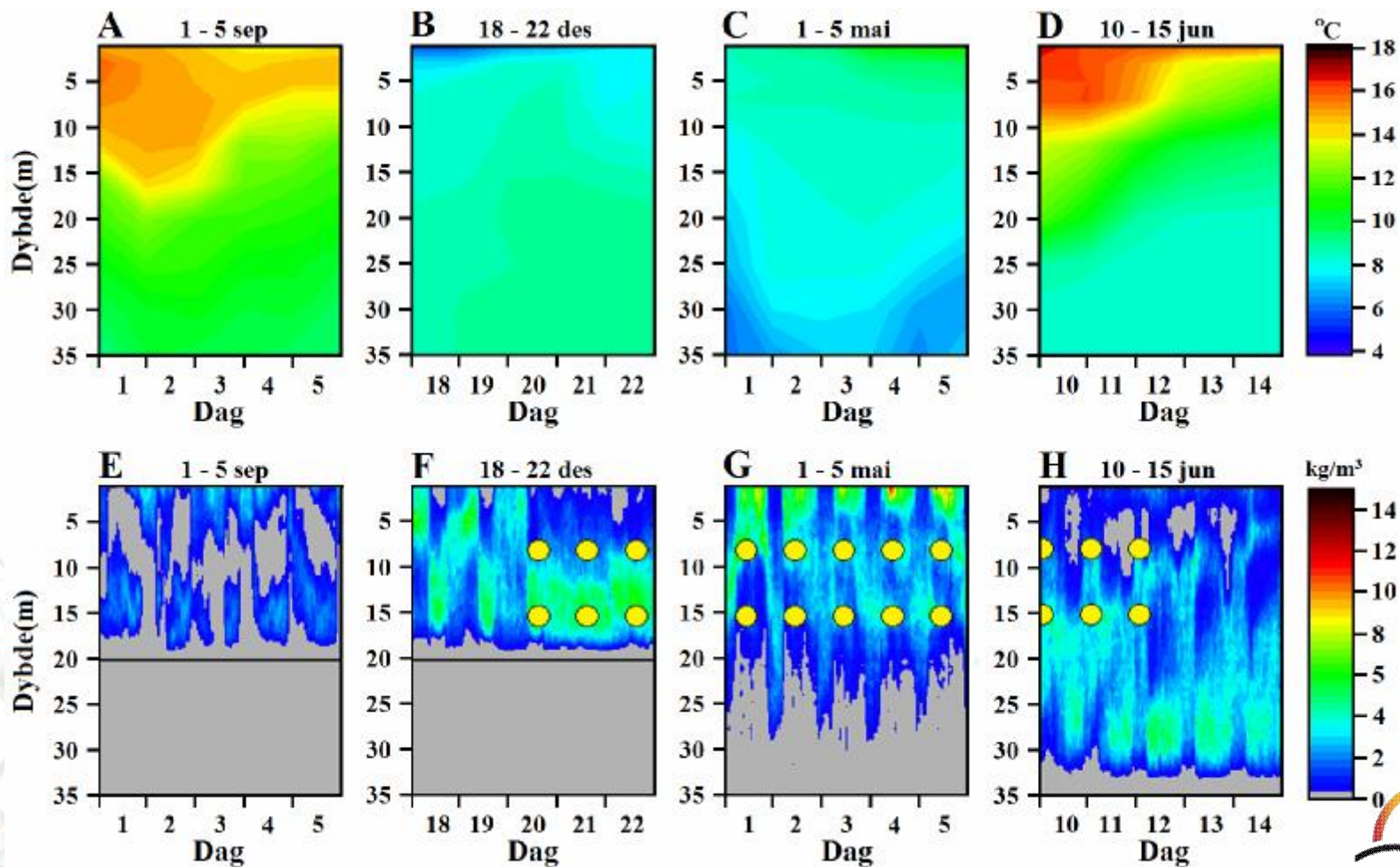



WELFAREMETER

2gen

Som del av WELFARE-TOOLS-prosjektet skal SmartTag-teknologien tilpasses laks og bli en del av Velferdsometersystemet (dvs sende data til Velferdsometerdatabasen).

SmartTag er sensorer for pustemønster til enkeltfisk utviklet av NOFIMA Marin (Øyvind Aas Hansen) og Thelma AS.

What is SmartTag?



The SmartTag provides online measurements of breathing pattern in free-swimming fish

- Monitor and document fish welfare status in aquaculture
- Early warning system
- Optimize production regimes
- Assess feed intake rates



SLAF-OCOPria 04888/AQUA 2006, 14 May 2006, Eivind





WELFAREMETER

2gen

Den nye Velferdsmeterbøyn skal serieproduseres.





WELFAREMETER

PROFILERENDE MÅLEINSTRUMENTER

Argus/SAIV: teknologileverandør
Ekkolodd (UiO, Lindem)

DATABASE OG DATAANALYSE

Havforskningsinstituttet (Norsk Marint Datasenter):
ekspertsystemer, dataanalyse
og sikker langtidslagring

Kontinuerlig oppdatering mot ny kunnskap

www.imr.no/welfaremeter

SmartTag digital

NOFIMA marin, Thelma Biotel





WELFAREMETER

Neste utfordring: Tåler den dette?



Bjørøya Fiskeoppdret AS, Flatanger





WELFARE METER *2gen*

Utviklingen av Velferdsmeteret har mottatt finansiell støtte fra Fiskeri- og havbruksnæringens forskningsfond, Norges forskningsråd (prosjekt 190259, WELFARE-TOOLS), EU (prosjekt 022720, FASTFISH) og Nord-Trøndelag Fylkeskommune.

I tillegg ønsker vi å takke SAIV AS, STM-maskinering AS og ARGUS Remote Systems AS som har lagt ned betydelig egeninnsats og vist stor entusiasme i utviklingen av den automatisk profilerende målebøyen.



NYTT NFR PROSJEKT:
Overall animal welfare assessment of Atlantic Salmon
(SALMOWA)

Helhetlig velferdsvurdering

- Kunnskap om dyrenes atferd og fysiologi og deres oppdrettsmiljø brukes på en formalisert og systematisk måte for å vurdere velferden.
- Formalisert metode – Semantisk modellering
- Vil utvikle en standardisert metode for helhetlig vurdering av fiskevelferd (for laks)
- SWIM – Salmon Welfare Index Method
- Vil bli implementert i Velferdmeter ekspertsystem



SALMOWA

www.imr.no/salmowa

[Home](#)

[The SALMOWA project](#)

[Whats's New?](#)

[Work Packages](#)

Project

SALMOWA - Overall welfare assessment (OWA) of farmed salmon (SALM).

Project period: 2010-2012

Contact

[Tore S. Kristiansen](#)
Research group leader
[Animal welfare](#)

Telephone:

 +47 92069918 



The SALMOWA project

In Norway farmed fish are protected by the same welfare legislations as land animals. However, since there are no established methods to assess or document fish welfare, it is impossible to know how to comply with these regulations or control or enforce them. To address this need, we will construct an integrating model and tool for overall welfare assessment of farmed Atlantic salmon.

[23.03.10] [read more](#)

Financed by

[The Fishery and Aquaculture Industry Research Fund](#)

[The Research Council of Norway](#)

First meeting

The startup meeting for the SALMOWA-project was held at Matre Research Station, March 9-

Work Packages

The project holds three work packages: